



U0093
93 дет



ГЕРАДЕКС



A5



A10

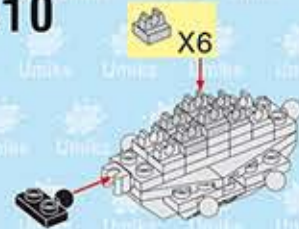

A15

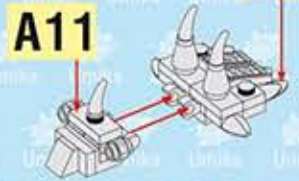

A6

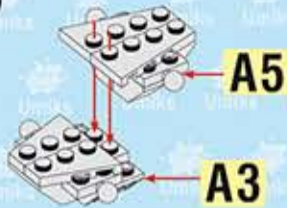

A11



A16

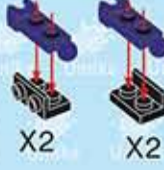

A17



A7



A12

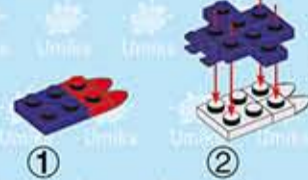

A18

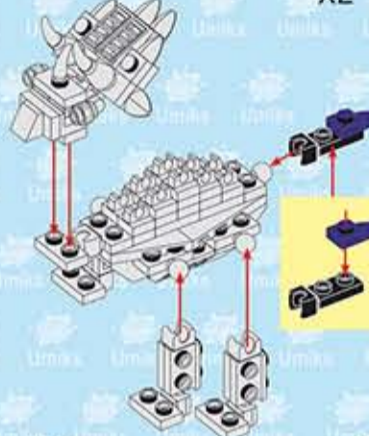

A1

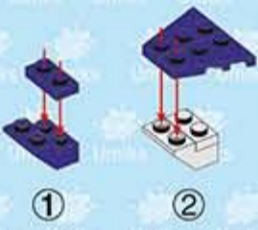

A3



A8



A13

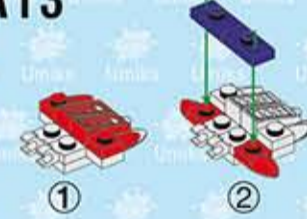

A19

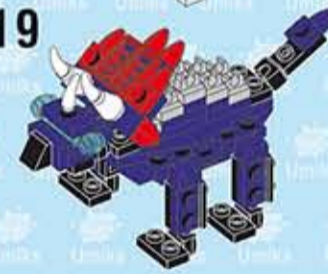

A2

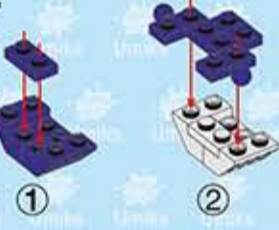

A4

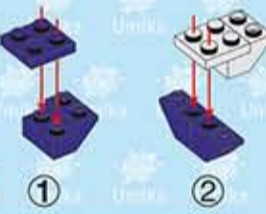

A9

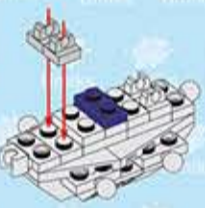

A14

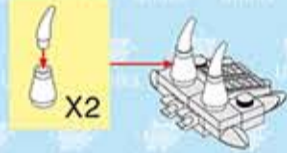

B1

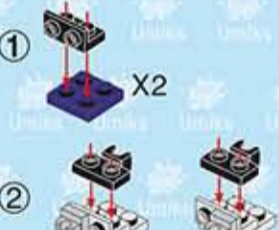

B5



B10

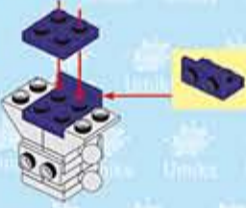

B15

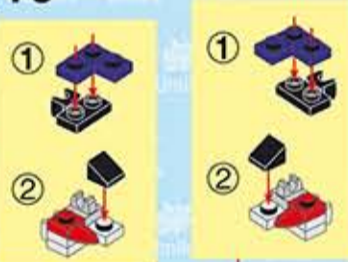

B16



B2

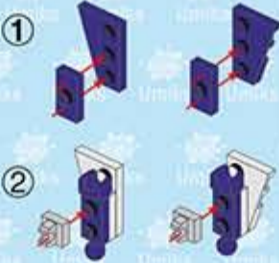

B6

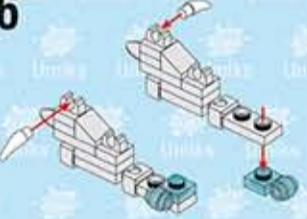

B11



B17

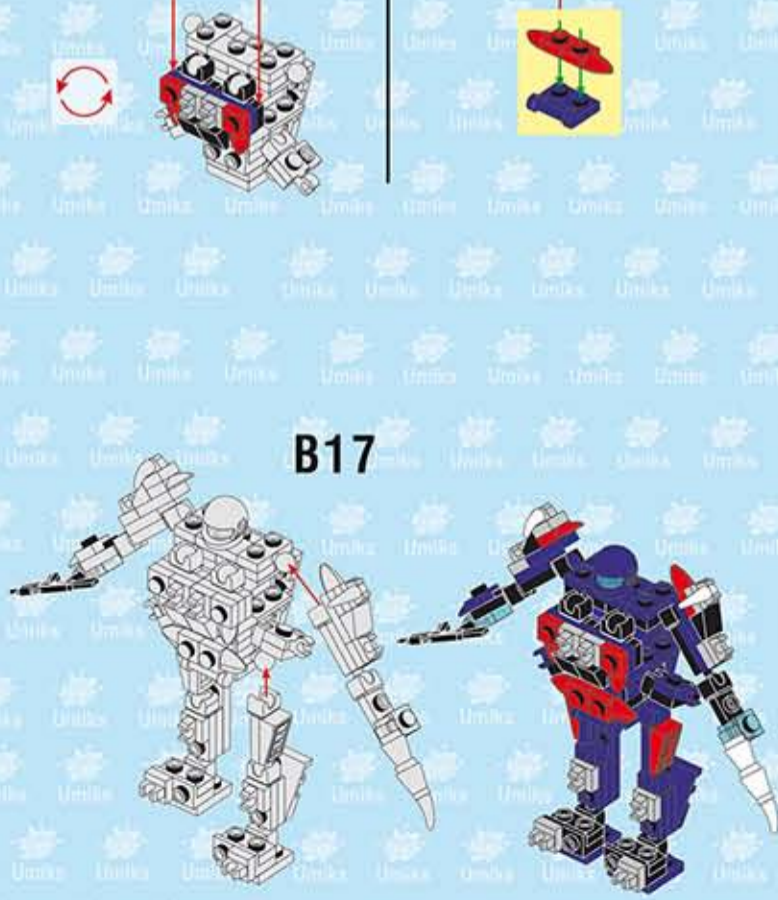

B3



B7

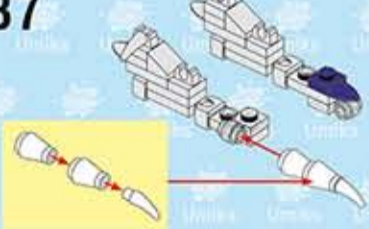

B12



B2

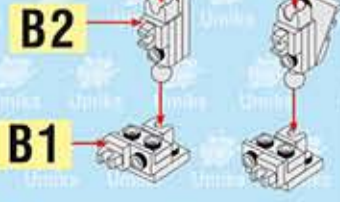

B8

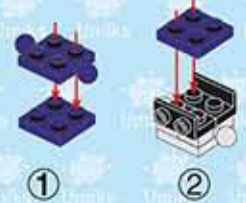

B13



B4



B9



B14

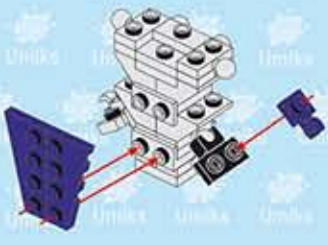



СОБЕРИ ВСЮ КОЛЛЕКЦИЮ И СДЕЛАЙ БОЛЬШОГО МЕГАБОТА



МЕГАБОТ

A1

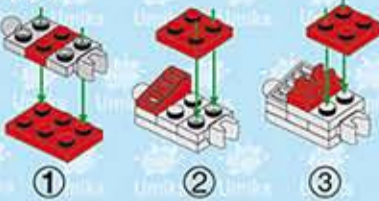

A3

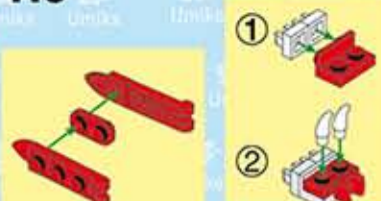

A2



A2

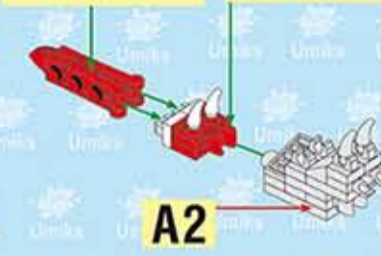

B1

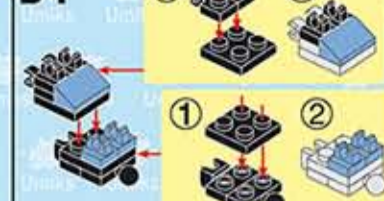

B3



B2

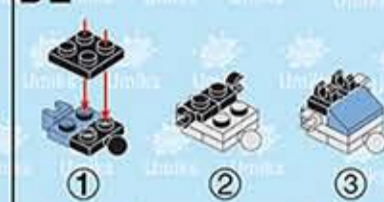

B1



B2

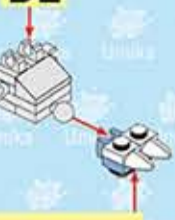

C1

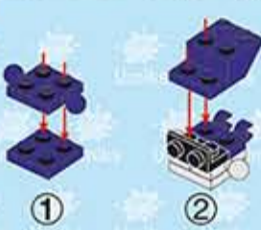

C2

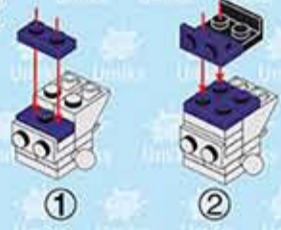

C3

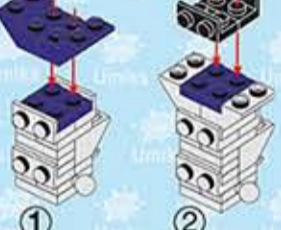

C4



C5



C6



C7

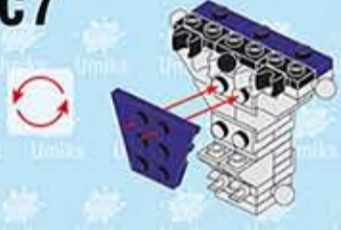

C8

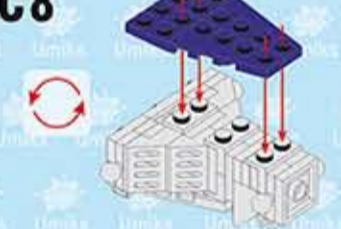

C9



C10



C11



C12

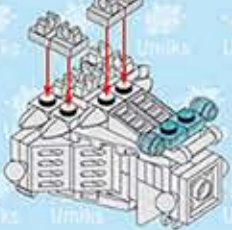

D1



D2

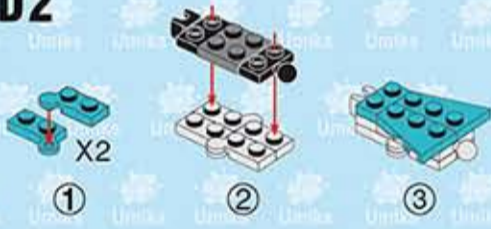

D3

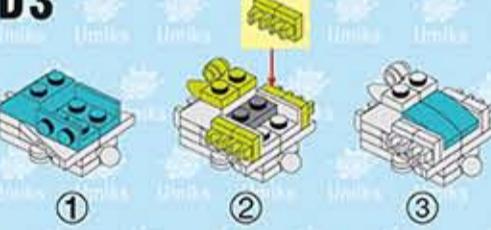

D4

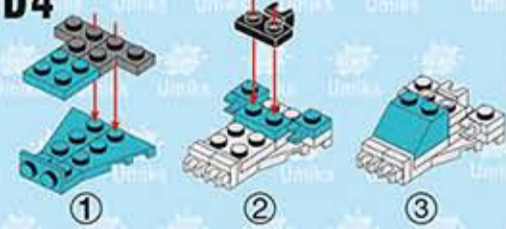

D5

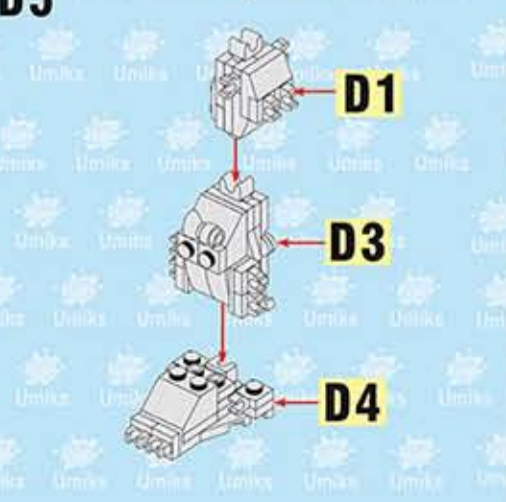

E1



E2



E3



E4

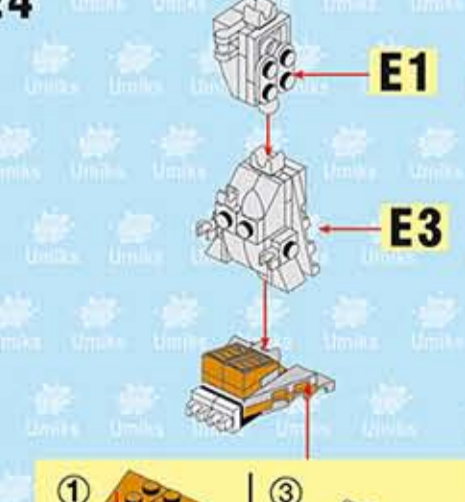

E1



E3

